

INTERMEDIATE:

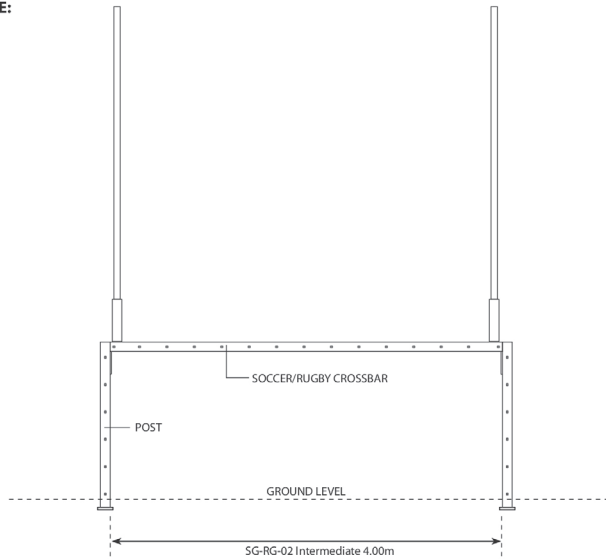

SENIOR:

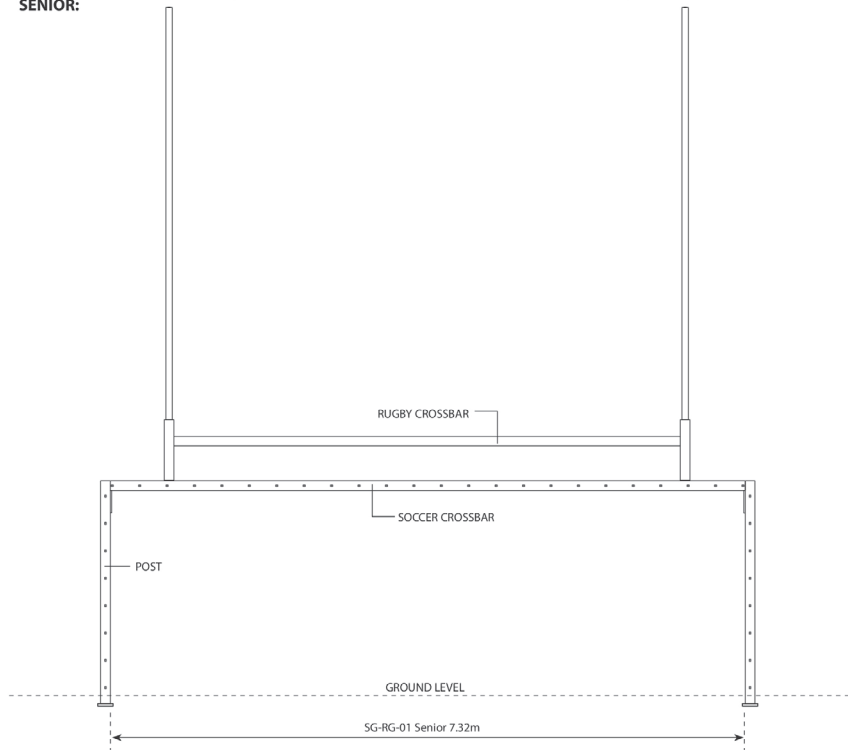

GROUND ANCHOR INSTALLATION:

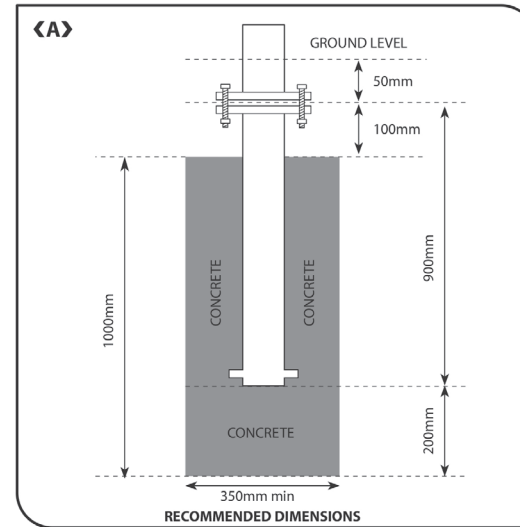

CONTENTS CHECKLIST:

- 2 x post ground anchors
- 2 x goal posts
- 1 x crossbar
- 8 x 12x50 set screw post fasteners
- 16 x 12mm washers
- 4 x 90x12mm crossbar cap screws
- 2 x 50x12mm crossbar set screws
- 2 x post extensions
- 2 x 10mm grub screws

INSTALLATION:

- Two persons recommended.

RECOMMENDATIONS FOR INSTALLATION OF GROUND ANCHORS:

- Ref. Diag<A> for ground anchor foundation details.
- To ensure accurate installation, cement in place with ground anchors attached to the posts with the crossbar fastened in place (follow assembly instructions below).
- Check posts for plumb and crossbar for level. Note: Ensure concrete level allows adequate space for the removal and fastening of post - ground anchor bolts and nuts. Ref. Diag<A>.

ASSEMBLY INSTRUCTIONS:

- Attach the post to the crossbar ensuring the net clips are aligned. Ref. Diag.
- Repeat for each post.
- Insert the post uprights and tighten the grub screws. Repeat for each post. Ref. Diag<C>.
- Erect posts. Ref. Diag<D>. It is recommended that one person hold the base of the post with their foot whilst the other walks the post up slowly. **Note:** Ensure that the net clips are facing away from the field.
- Fasten the base of the post to the ground anchor and tighten. Ref. Diag<E>.
- Attach the net to the goal, starting from the top corners of the goal, keeping tension on the net as it is clipped for best results. Ref. Diag<F>.

PLAY BALL!

FIXING THE CROSSBAR TO THE POSTS:

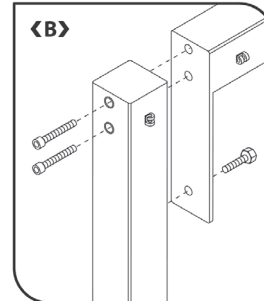

INSERTING THE POST UPRIGHTS:

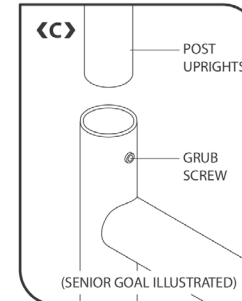

INSERTING THE POST UPRIGHTS:

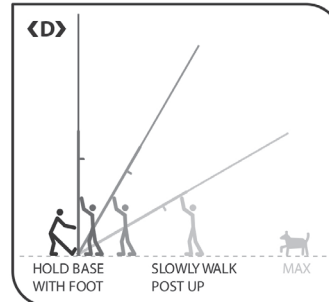

FASTENING THE POSTS TO THE GROUND ANCHORS:

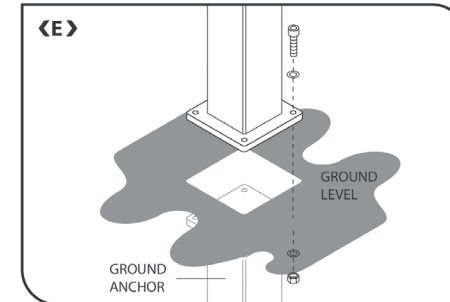

ATTACHING THE NET TO THE NET CLIPS:

